



# Specifications

## Edge 100 W/C Composite Wood Garden Edging

Length 2900mm | Width 16mm | High 100mm

---



### Finishes

- Dark Chocolate
- Dark Grey

---

### Accessories

Straight Joiner

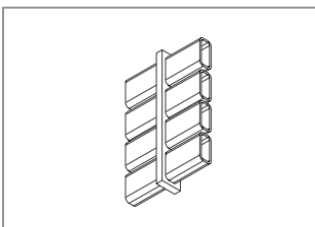

Corner Joiner

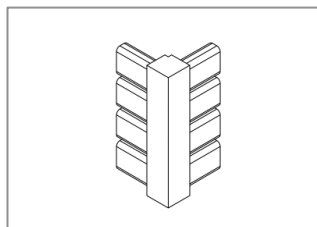

Fixing Spike



Spike Guide





# Installation Guide

## Eco Edge 100

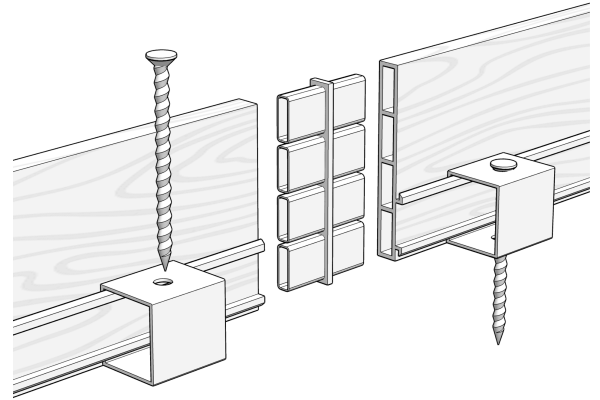

### Site Preparation

Hedge can be placed directly onto soil, road base, sand, concrete surfaces & slabs. Site prep required is at the discretion of the installer dependent on above or below ground use.

### Joining

Simply insert Hedge custom made straight joiners into the edging profile for a seamless, uninterrupted garden edge.

### Cutting

For best results, cut garden edging using an electric drop saw. \*Metal cutting blade not required.

### Fixings

- ✔ Use 4 x 250mm Fixing Spike per length
- ✔ Use 1 x Spike Guide per 250mm spike

### Corners

Achieving the perfect right angle is easy with Hedge custom made corner joiners. No additional screws or fixings are required.

### Curves

Bend WC edge to the desired shape to create sweeping curves easily.

Step 1 - Join

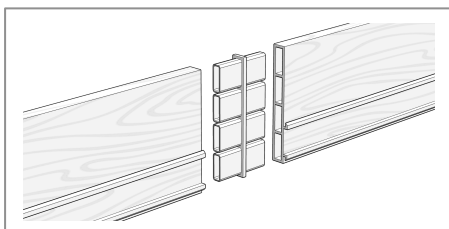

Step 2 - Connect

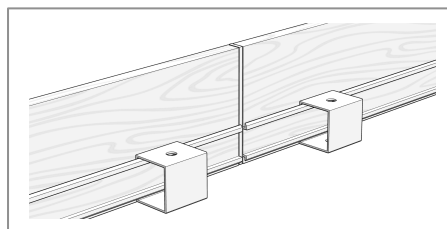

Step 3 - Corners

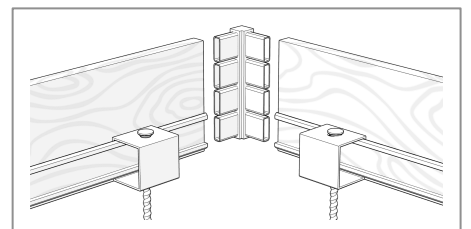

Step 4 - Install

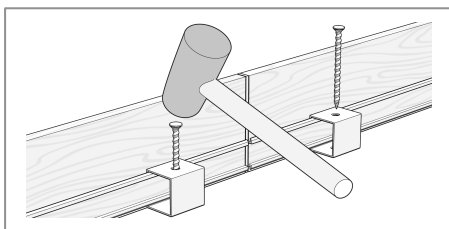

Step 5 - Curves

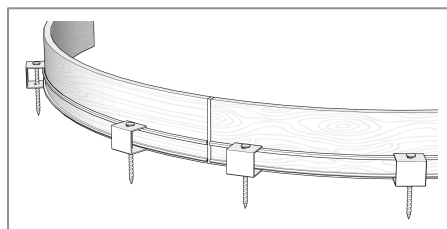

Step 6 - Backfill

